

Article number: 03215010

Description: Fluro Rod End GILRS 10-R

Housing and ball in stainless steel with left-handed thread

Measures

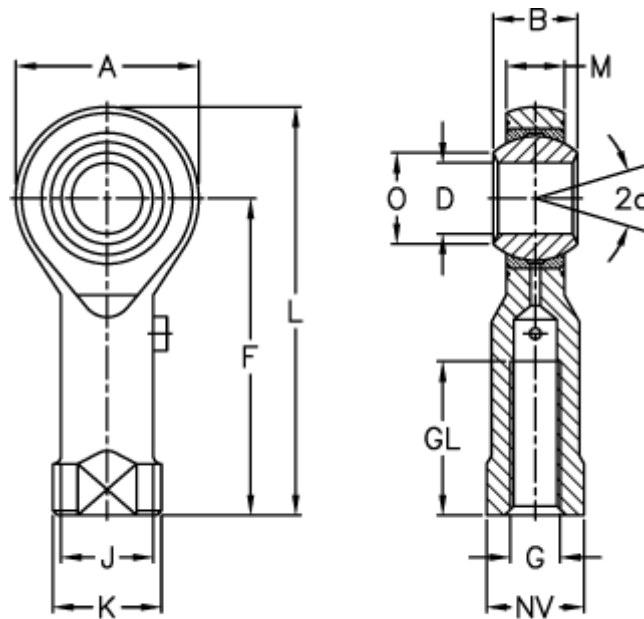

Str. 3 uden smørenippel

A	= 28	J	= 15	Weight (g) = 76
a (degrees)	= 13	K	= 19	
B	= 14	L	= 57	
D	= 10	M	= 10.5	
Dynamic load C (kN)	= 10	NV	= 17	
F	= 43	O	= 12.9	
G	= M10	Permissible rpm	= 1000	
GL	= 20	Static load C0 (kN)	= 28.3	